

Features

- * Medium size, 22mm width solenoid valve, large flow rate.
- * Lockable manual override for easy operation.
- * Anodized aluminum body and strict quality control provide a long durability.
- * Ex-proof coil is available, please refer to page 7-6.



How to order

BM520	X	02	N	S	2	LED	E
22mm valves series	Acting style	Port size	Thread	Solenoid	Voltage	LED	Coil type
52 5/2 way 53 5/3 way	Blank Standard X Exhaust center Y Pressurized center	02 1/4"	Blank PS N NPT	S Single solenoid D Double solenoid	1 110VAC 2 220VAC 9 24VDC	Blank (W/O LED)	Blank DIN E Ex-proof

How to order manifold

MFB520	02	N	02
22mm valves series	Port size	Thread	Stations
	1/4"	Blank PS N NPT	02 2 stations 03 3 stations XX XX stations

Specifications

Model	BM520-02-S	BM520-02-D	BM530-02-D
Port size	1/4", 1/8" (Exhaust ports)		
Fluid	Compressed air		
Acting	Internal pilot		
Sectional area	18mm ²	14mm ²	
Operating pressure range	1.5~8 kgf/cm ²	2~8 kgf/cm ²	
Max. operating pressure	9.9 kgf/cm ²		
Ambient temperature	-10°C ~ 50°C		
Duty cycle	100% ED		
Coil type	DIN (Standard)		
Protection class	IP65 (DIN 40 050)		
Insulation class	F		
Voltage tolerance	±10%		
Standard voltage	220VAC, 110VAC, 24VDC (The other voltage is optional)		
Net weight	235g	335g	445g

Flow chart

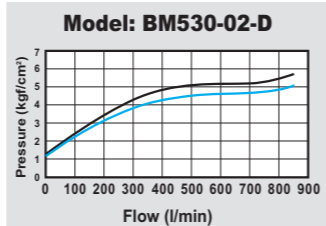
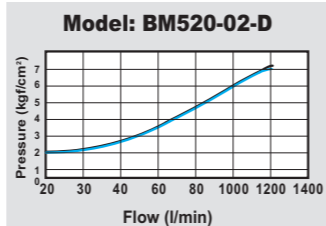
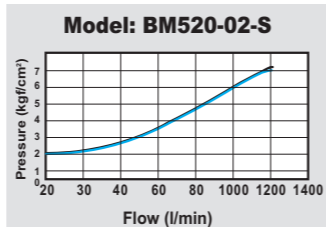

Dimensions

BM520-02-S

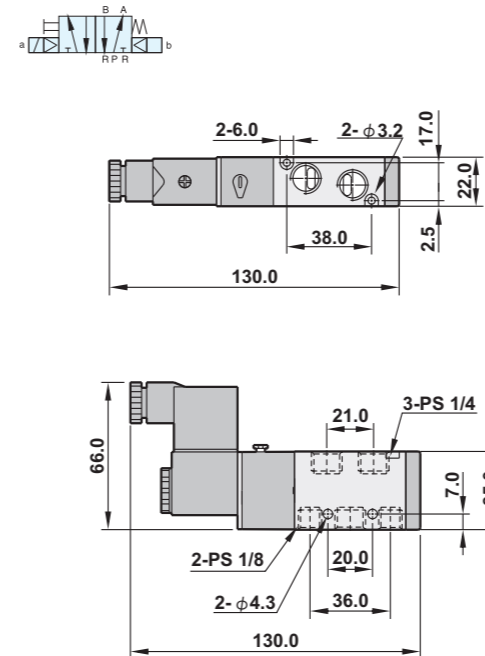

BM520-02-D

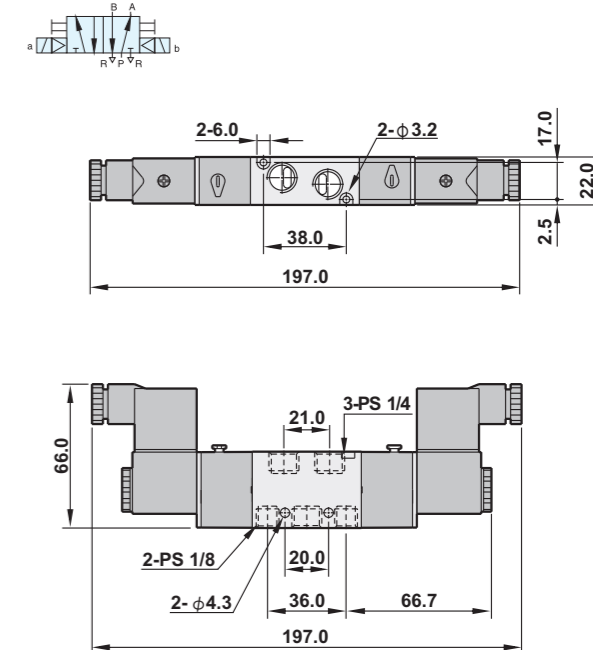

BM530-02-D

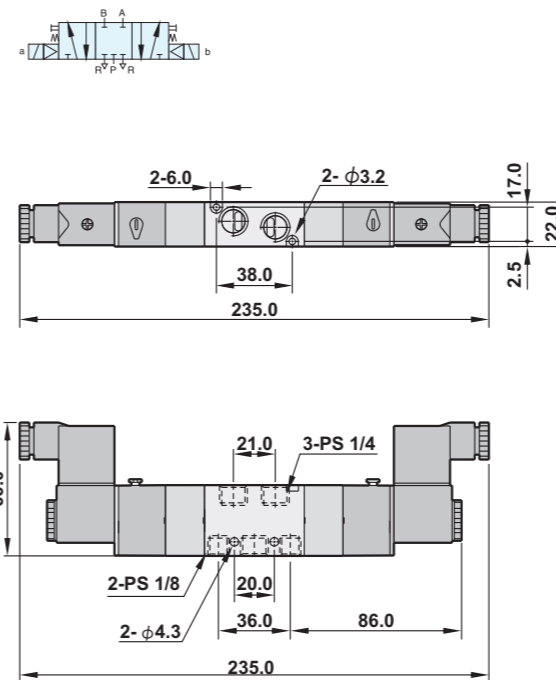

MFB520-02-06

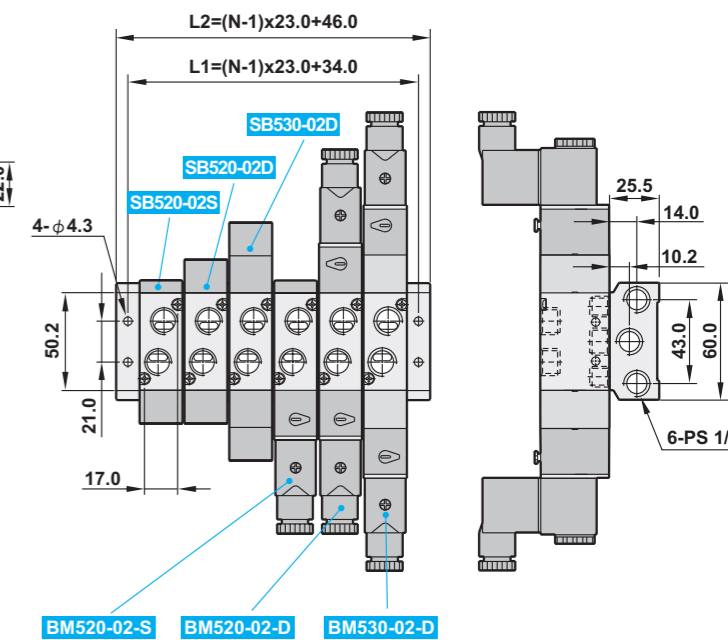

Number of station (N)	2	3	4	5	6	7	8	9	10
L1	57.0	80.0	103.0	126.0	149.0	172.0	195.0	218.0	241.0
L2	69.0	92.0	115.0	138.0	161.0	184.0	207.0	230.0	253.0